

BRX



SMART

BRX

SMART: PROGETTO INTELLIGENTE PER UNA NUOVA IDEA DI LOCALE

SMART: A CLEVER PROJECT
FOR A NEW RETAIL PLACE CONCEPT

CAMBIANO LE ESIGENZE DI MERCATO E LE RICHIESTE DEI CLIENTI: LA TENDENZA COMMERCIALE DEL MOMENTO È IL LOCALE TRASVERSALE CHE OFFRE NON PIÙ UNA SOLA PROPOSTA, MA MOLTEPLICI SERVIZI. LA PASTICCERIA DIVENTA CAFFETTERIA E PANETTERIA, LA PANETTERIA È ANCHE GASTRONOMIA, TAVOLA CALDA E TAVOLA FREDDA. NASCE COSÌ SMART, LA NUOVA VETRINA FUNZIONALE AD OGNI ESIGENZA.

MARKET NEEDS AND CUSTOMER REQUESTS CHANGE: THE LATEST SALES TREND IS THE UNCONVENTIONAL PLACE FOR MULTIPLE SERVICES, NOT JUST A SINGLE OFFER. A CONFECTIONERY BECOMES COFFEE BAR AND BAKERY, A BAKERY BECOMES A DELICATESSEN SHOP, SNACK BAR AND BUFFET TOO. THE RESULT IS SMART, A NEW FUNCTIONAL DISPLAY CASE FOR EVERY NEED.



PER UN
PRANZO DI
LAVORO
FOR A BUSINESS LUNCH



PER UN
HAPPY HOUR
IN COMPAGNIA!
FOR A HAPPY HOUR
IN GOOD COMPANY!



UNA COLAZIONE
VELOCE ...
O UN MOMENTO
DI RELAX CON
GLI AMICI
A QUICK BREAKFAST...
OR A RELAXING MOMENT
WITH FRIENDS



PER LA SPESA
DI TUTTI I GIORNI
FOR EVERYDAY SHOPPING

SMART

UNA VETRINA, MILLE LOCALI

SMART: A DISPLAY CASE...
A THOUSAND RETAIL SPACES



PASTICCERIA,
CAFFETTERIA
E PANETTERIA:
UNICA SOLUZIONE
DI CONTINUITÀ

CONFECTIONERY, COFFEE BAR
AND BAKERY: A SINGLE
CONSISTENT SOLUTION

PERFETTA ORGANIZZAZIONE DELLO SPAZIO

PERFECT ORGANIZATION OF SPACE

CONVIVONO IN UN'UNICA COMPOSIZIONE
LE VETRINE PER PASTICCERIA E
PANETTERIA CHE SI INTEGRANO
PERFETTAMENTE
AL BANCO BAR E CAFFETTERIA

CONFECTIONERY AND BAKERY DISPLAY CASES COEXIST IN A
SINGLE COMPOSITION AND THEY ARE PERFECTLY INTEGRATED
TO THE BAR AND COFFEE BAR COUNTER.

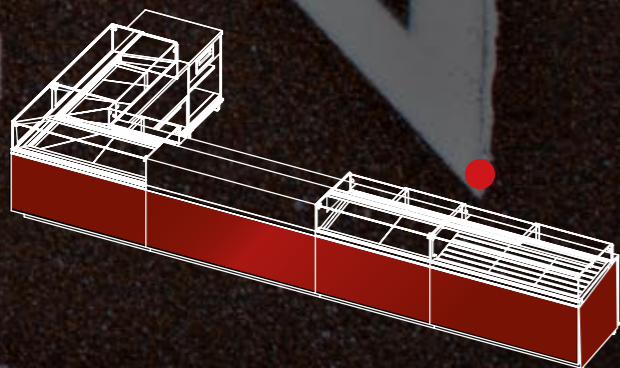

TECNOLOGIA
A SUPPORTO
DELLA MIGLIORE
ESPOSIZIONE

TECHNOLOGY IN SUPPORT
OF BETTER DISPLAYING

UN BANCO PERFETTAMENTE CANALIZZATO: PER CREARE
LA GIUSTA CONTINUITÀ E INTEGRAZIONE IN TUTTA LA COMPOSIZIONE.

A COUNTER EQUIPPED WITH A PERFECT DUCT SYSTEM: TO CREATE THE RIGHT CONSISTENCY
AND INTEGRATION WITH THE OVERALL COMPOSITION.

BRX





PP

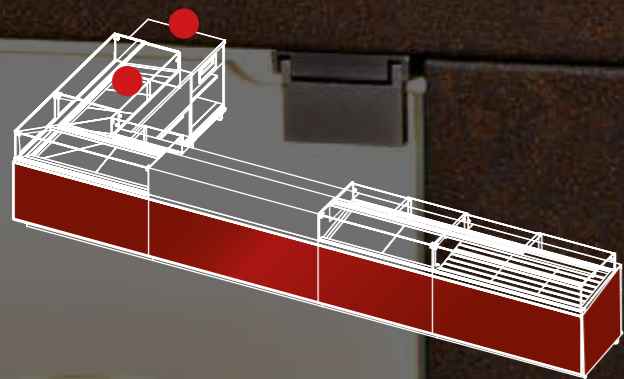

MASSIMA ATTENZIONE
 ALLA VISIONE D'INSIEME
 FOCUS ON THE BIG PICTURE

LA VETRINA PASTICCERIA HA IL PIANO
 ESPOSITIVO INCLINATO.
 RIPIANI A DUE "GRADONI" OPTIONAL.

THE CONFECTIONARY DISPLAY CASE FEATURES SLOPED DISPLAY.
 THE TWO-STEPS SHELF IS OPTIONAL



L'ANGOLO A 90° AMPLIA LA VISIONE D'INSIEME
OTTIMIZZANDO GLI SPAZI E RENDENDO LA
VISTA DEI PRODOTTI PIÙ INVITANTE.
RIPIANI ESPOSITIVI A "GRADONI" OPTIONAL.

THE 90° CORNER WIDENS THE OVERALL VIEW, OPTIMIZING SPACES
AND MAKING THE VIEW OF THE PRODUCTS MORE INVITING.
DISPLAY SHELVES WITH "STEPS" ARE OPTIONAL.



PRALINERIA: UN PROGETTO AL SERVIZIO DI QUALCOSA DI SPECIALE

PRALINE SHOP: A PROJECT AT THE
SERVICE OF SOMETHING SPECIAL

IL BANCO SMART PER LA PRALINERIA È
DOTATO DI SISTEMA PER IL CONTROLLO
DELL'UMIDITÀ E TEMPERATURA.

THE SMART DISPLAY CASE FOR PRALINE SHOPS IS EQUIPPED
WITH A HUMIDITY AND TEMPERATURE CONTROL SYSTEM.



TECNOLOGIA E RICERCA
SI EVOLVONO CON LE TUE
ESIGENZE

TECHNOLOGY AND
RESEARCH EVOLVING
WITH YOUR NEEDS

NOVITÀ BRX: LA PANETTERIA È ANCHE GASTRONOMIA

BRX NEWS: BAKERY AND DELICATESSEN
SHOP AT THE SAME TIME



L'INNOVAZIONE
TECNOLOGICA
MIGLIORA
L'ESPOSIZIONE

TECHNOLOGICAL INNOVATION
ENHANCES DISPLAYING

I PIANI CONTINUI NON HANNO
INTERRUZIONI. L'ANGOLO A 90° MIGLIORA LA
CAPIENZA E L'ESTETICA DELL'ESPOSIZIONE.

THE CONTINUOUS TOPS HAVE NO SEAMS
THE 90° CORNER IMPROVES CAPACITY AND
AESTHETICS OF THE DISPLAY.

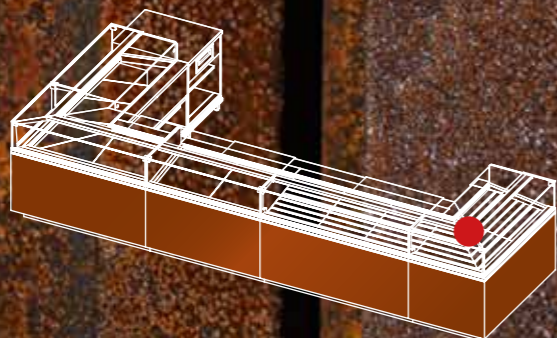

P

T

S

T



POSSIBILITÀ DI CANALIZZAZIONE
CONTINUA TRA LE DIFFERENTI
VETRINE: PANE, PIZZA,
CALDO SECCO O NEUTRE,
SENZA RICORRERE
AL FIANCO DIVISORIO

THERE IS THE POSSIBILITY OF CONTINUOUS
DUCT SYSTEMS AMONG THE VARIOUS DISPLAY
CASES: BREAD, PIZZA, DRY HOT OR
NON-REFRIGERATED, WITHOUT
NEED FOR A PARTITION SIDE



FORNITO STANDARD IL PRATICO
VASSOIO ESTRAIBILE PER
RACCOGLIERE LE BRICIOLE.

PROVIDED THE STANDARD PRACTICE
PULL-OUT FOR TRAY COLLECT CRUMBS.



I RIPIANI IN LEGNO DOGATO
PER LA PANETTERIA SONO
SIA ESTETICI CHE FUNZIONALI.

THE SLATTED WOODEN SHELVES FOR THE BAKERY
ARE BOTH AESTHETICALLY PLEASING AND FUNCTIONAL.

MASSIMA CURA DI ACCESSORI
E RIFINITURE

ACCESSORIES AND FINISHES
REFINED TO THE FINEST DETAIL

UNA PERFETTA CANALIZZAZIONE L' ILLUMINAZIONE LED SEGUE TUTTO IL PERIMETRO

BRX

PERFECT CANALIZATION. LED LIGHTING ALONG THE ENTIRE PERIMETER



PENSATA PER OFFRIRE
SEMPRE DI PIU'

DESIGNED TO OFFER ALWAYS MORE

BRX



LO SPAZIO E' GESTITO NEI MINIMI
DETTAGLI, OGNI ELEMENTO CONCORRE
ALLA SUA OTTIMIZZAZIONE E I PIANI
ESPOSITIVI SONO MODULATI SULLE
MISURE EURONORM 60X40.

THE SPACE IS DESIGNED IN EVERY DETAIL,
EVERY ELEMENT CONTRIBUTES TO ITS OPTIMIZATION
AND THE DISPLAY SHELVES COMPLY WITH THE EURO-
STANDARD SIZE OF 60X40

I RIPIANI INCLINATI INOX LUCIDO(DI
SERIE) O CON DOPPIO "GRADONE"
(OPTIONAL) SI COMPONGONO IN BASE
ALLE ESIGENZE D' ESPOSIZIONE, PER
SODDISFARE I GUSTI DEL CLIENTE.

THE SLOPED SHELVES IN POLISHED STAINLESS STEEL
(STANDARD) OR FEATURING TWO "LARGE STEPS"
(OPTIONAL) ARE COMBINED DEPENDING ON THE DISPLAY
NEEDS, TO SATISFY THE TASTES OF THE CUSTOMER.



UNA NUOVA
IDEA DI
ESPOSIZIONE

A NEW DISPLAY CONCEPT

SMART:
UN PRODOTTO COMPLETO
E PERSONALIZZABILE.

SMART: A COMPLETE AND CUSTOMIZABLE PRODUCT



LUCE E TRASPARENZE CHE CATTURANO LO SGUARDO

LIGHT AND TRANSPARENCY
THAT CATCH THE EYE

PENSATA ANCHE PER IL SERVIZIO TAKE
AWAY, TAVOLA CALDA E FREDDA.
CAMBIANO I CANONI DELL'ACCOGLIENZA
PER UN TIPO DI LOCALE APERTO A NUOVE
ESIGENZE.

DESIGNED ALSO FOR A TAKE-OUT SERVICE, SNACK BAR AND
BUFFET. THE RULES OF HOSPITALITY CHANGE FOR RETAIL
PLACES OPEN TO NEW NEEDS



VETRINA CALDO SECCO O
NEUTRA VETRI ALTI.
ILLUMINAZIONE LED DELLA
MENSOLA (OPTIONAL).

Dry-heated or non-refrigerated display
case equipped with high glass.
LED lighting of the shelves is optional

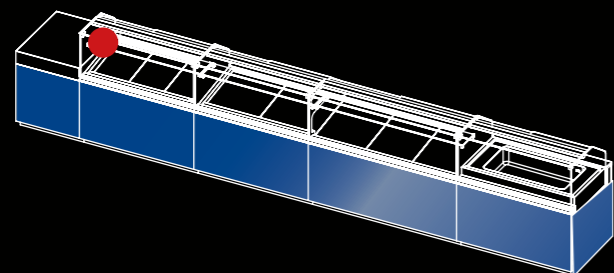

COME CONSERVARE AL MEGLIO LA FRESCHEZZA

HOW TO PRESERVE
FRESHNESS AT ITS BEST



PASTICCERIA, FRUTTERIA-YOGURTERIA E SNACK: LA TEMPERATURA IDEALE PER PRESERVARE AL MEGLIO LA BONTÀ DI TUTTI I CIBI FRESCI.

CONFECTIONERY, FRUIT-YOGURT SHOP AND SNACK BAR: THE IDEAL TEMPERATURE TO PRESERVE FRESH FOODS QUALITY AT ITS BEST.



I RIPIANI CON GRADONI, DISPONIBILI SOLO PER LA VETRINA REFRIGERATA, PREVEDONO L'INSERIMENTO DI VASCHE GASTRONORM PER TUTTI I CIBI FRESCI, LIQUIDI O IN SALAMOIA: IDEALI PER FRUTTERIA E GASTRONOMIA

THE STEPPED SHELVES, AVAILABLE FOR THE REFRIGERATED DISPLAY CASE, ALSO INCLUDE THE POSSIBILITY TO ADD GASTRONORM TRAYS FOR ALL FRESH, LIQUID, OR PICKLED FOODS: IDEAL FOR FRUIT, YOGURT AND DELICATESSEN.



UN SERVIZIO A 360°
FULL SERVICE ALL AROUND

BRX



PER UN AMBIENTE RICCO DI OSPITALITÀ
TO CREATE A WELCOMING ENVIRONMENT.





PRALINERIA

PRALINE SHOP

UNA MACCHINA STUDIATA PER LA PERFETTA CONSERVAZIONE DEL PRODOTTO: MANTIENE TEMPERATURA E UMIDITÀ COSTANTI PER NON ALTERARE IL GUSTO DEGLI INGREDIENTI E DEL CIOCCOLATO.

A PIECE OF EQUIPMENT DESIGNED FOR THE PERFECT PRESERVATION OF THE PRODUCT. IT MAINTAINS CONSTANT TEMPERATURE AND HUMIDITY TO PRESERVE THE TASTE OF CHOCOLATE AND INGREDIENTS.



STUDIATA IN OGNI DETTAGLIO

THOUGHT OUT IN EVERY DETAIL

LA VETRINA CON ANGOLO APERTO
A 90° NON SOLO È PERFETTA PER
LA CONSERVAZIONE DELLA PASTICCERIA
MA GARANTISCE ANCHE UN'ESPOSIZIONE
INVITANTE E ACCATTIVANTE

THE DISPLAY CASE WITH 90° OPEN-CORNER IS NOT ONLY
PERFECT TO OPTIMALLY PRESERVE CONFECTIONERY
PRODUCTS, BUT ALSO TO ENSURE AN INVITING AND
APPEALING DISPLAY.



VETRINA ANGOLO 90° REFRIGERATA VENTILATA

REFRIGERATED AND VENTILATED
90° CORNER DISPLAY CASE





LA GIUSTA TEMPERATURA PER YOGURT, FRULLATI, SMOOTHIES, FRAPPÈ E MACEDONIE: PER CONSERVARE AL MEGLIO FRESCHEZZA, VITAMINE E PRINCIPI NUTRITIVI DEGLI ALIMENTI.

THE RIGHT TEMPERATURE FOR YOGURT, MILK SHAKES, SMOOTHIES, SHAKES AND FRUIT SALADS: TO BETTER PRESERVE FRESHNESS, VITAMINS AND NUTRITIONAL CONTENTS OF FOOD.



UNA VETRINA DALLA DUPLICE FUNZIONE: NELL'ARCO DELLA GIORNATA LA VETRINA REFRIGERATA DIVENTA CALDO SECCO E VICEVERSA, PER CONSERVARE DIVERSE TIPOLOGIE DI CIBO.

A DUAL-FUNCTION DISPLAY CASE: DURING THE DAY THE REFRIGERATED DISPLAY CASE BECOMES DRY HOT, AND VICE VERSA, IN ORDER TO PRESERVE DIFFERENT TYPES OF FOOD.



VETRINA REFRIGERATA VENTILATA / DOPPIA FUNZIONE

REFRIGERATED, VENTILATED/DUAL FUNCTION DISPLAY CASE

LE VETRINE REFRIGERATE LINEARI SONO DISPONIBILI ANCHE NELLA VERSIONE DOPPIA FUNZIONE: FREDDO VENTILATO E CALDO A CONTATTO.

THE LINEAR REFRIGERATED DISPLAY CASES ARE ALSO AVAILABLE IN THE DUAL-FUNCTION VERSION: VENTILATED COLD AND HOT UPON CONTACT





ESPOSIZIONE CURATA CON
LA VETRINA LINEARE A VETRI BASSI
E RIPIANI IN LEGNO DOGATO

A REFINED DISPLAY THANKS TO THE LINEAR
DISPLAY CASE WITH LOW GLASS SOLUTION AND
SLATTED WOODEN SHELVES.

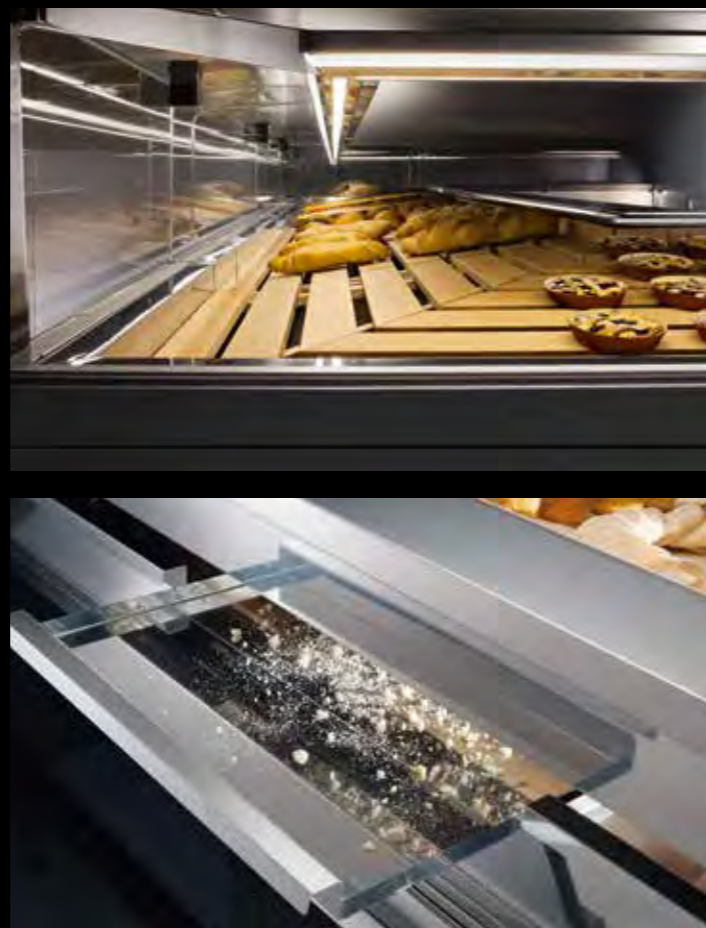

I RIPIANI IN LEGNO DOGATO HANNO
VALENZA "ESTETICO-FUNZIONALE":
È DI PRATICA UTILITÀ IL VASSOIO
ESTRAIBILE PER RACCOGLIERE
LE BRICIOLE

THE SLATTED WOODEN SHELVES HAVE AN "AESTHETIC-
FUNCTIONAL" VALUE; THE PULL-OUT TRAY
TO COLLECT CRUMBS IS OF PRACTICAL USE.

PANETTERIA BAKERY



CALDO SECCO / PIZZA / NEUTRA
 DRY HOT / PIZZA / NON-REFRIGERATED

IL MIGLIOR MODO DI ESPORRE LA BONTÀ

THE BEST WAY TO DISPLAY GOODNESS

LA TECNOLOGIA BRX PREVEDE
 LA CONVIVENZA DI CIBI CALDI O A
 TEMPERATURA AMBIENTE NELLA
 STESSA CONFIGURAZIONE, PER LA
 MASSIMA OTTIMIZZAZIONE DEGLI SPAZI.

BRX TECHNOLOGY ALLOWS THE COMBINATION OF HOT OR
 AMBIENT TEMPERATURE FOOD IN THE SAME DISPLAY, FOR
 MAXIMUM SPACE OPTIMIZATION.



BAGNOMARIA

BAIN-MARIE

LA MIGLIOR TECNOLOGIA
AL SERVIZIO DEL LAVORO
THE BEST TECHNOLOGY AT WORK

LA VETRINA BAGNOMARIA
DISPONIBILE SOLO CON VETRI ALTI.

LA VASCA CON BORDI RAGGIATI
FACILITA LA PULIZIA.
DISPONIBILE ANCHE
CON CELLA REFRIGERATA.

THE DISPLAY CASE WITH BAIN-MARIE FUNCTION IS
AVAILABLE ONLY IN HIGH GLASS VERSION.

THE TUBS WITH RADIAL EDGES MAKE CLEANING EASIER.
ALSO AVAILABLE WITH REFRIGERATED CABINET.



STUDIATA PER ESPORRE QUALSIASI TIPO DI PRODOTTO

DESIGNED TO DISPLAY ANY TYPE OF PRODUCT

SMART VETRI ALTI DISPONIBILE IN TUTTE LE TIPOLOGIE.
SMART WITH HIGH GLASS AVAILABLE IN ALL VERSIONS.



CALDO SECCO / DRY HOT



PIZZA



PANE / BREAD



REFRIGERATO VENTILATO / REFRIGERATED VENTILATED

SMART VETRI ALTI

SMART WITH HIGH GLASS



UNA PULIZIA
VELOCE, FACILE
E SICURA

QUICK, EASY
AND SAFE CLEANING

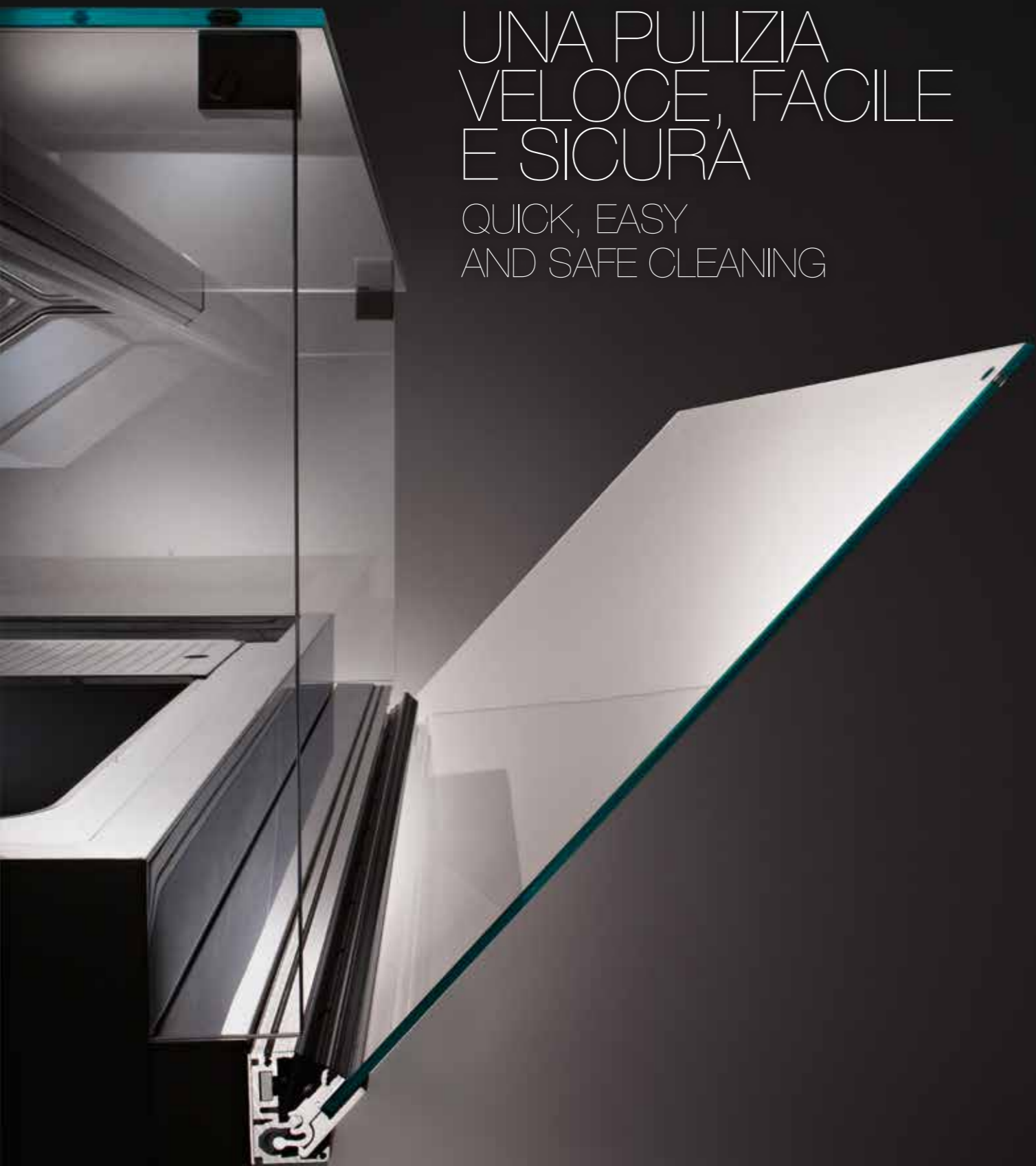

I CRISTALLI CON APERTURA DALL' ALTO
VERSO IL BASSO HANNO UN SISTEMA
DI AMMORTIZZAZIONE CHE FACILITA
PULIZIA E MANUTENZIONE.

GLASS SECTIONS WITH OPENING FROM TOP TO BOTTOM
FEATURE SHOCK ABSORBERS THAT FACILITATE CLEANING
AND MAINTENANCE.





ANTINE INOX
DOORS IN STAINLESS STEEL



CASSETTONI ESTRAZIONE TOTALE
FULL-EXTENSION DRAWERS

ATTREZZATA
PER MIGLIORARE
IL LAVORO
EQUIPPED TO
IMPROVE WORK



CELLE REFRIGERATE
REFRIGERATED CABINETS



QUALITÀ BRX VANI NEUTRI IN ACCIAIO
BRX-QUALITY NON-REFRIGERATED
COMPARTMENTS IN STEEL



MENSOLE PERFETTAMENTE CANALIZZATE
E INTEGRATE CON IL MONTANTE TRASPARENTE
AUMENTANO LA VISIONE SUL PRODOTTO,
RENDENDO PIÙ COMODO ED ERGONOMICO
IL LAVORO.

SHELVES PERFECTLY DUCTABLE AND INTEGRATED WITH
THE TRANSPARENT UPRIGHT INCREASE PRODUCT VISIBILITY,
MAKING WORK MORE COMFORTABLE AND ERGONOMIC.

COMPONI LA TUA SMART DESIGN YOUR OWN SMART

DI SERIE TETTINO CON DOPPIA ILLUMINAZIONE LED.
STANDARD CANOPY WITH DUAL LED LIGHTING.



VETRINA VETRI ALTI.
ILLUMINAZIONE LED DELLA MENSOLA (OPTIONAL)
DISPLAY CASE WITH HIGH GLASS
SHELF WITH LED LIGHTING (OPTIONAL)

UNA VETRINA COSÌ VERSATILE DA
SODDISFARE OGNI ESIGENZA: CON
RIPIANI E MENSOLE SPAZIOSI, PIANI
DI LAVORO COMODI, ATTREZZATA
PER OGNI TIPOLOGIA DI CIBO E
ILLUMINATA IN OGNI SUA PARTE PER
RENDERE OGNI PRODOTTO IL VERO
PROTAGONISTA

A DISPLAY CASE SO VERSATILE IT CAN MEET EVERY
NEED: SPACIOUS TOPS AND SHELVES, COMFORTABLE
WORK TOPS, EQUIPPED FOR ALL KINDS OF FOOD AND
THOROUGHLY ILLUMINATED TO MAKE EACH PRODUCT
A REAL PROTAGONIST



BANCO BAR E VETRINE PERFETTAMENTE INTEGRATE.
BAR COUNTER AND DISPLAY CASES ARE PERFECTLY INTEGRATED.

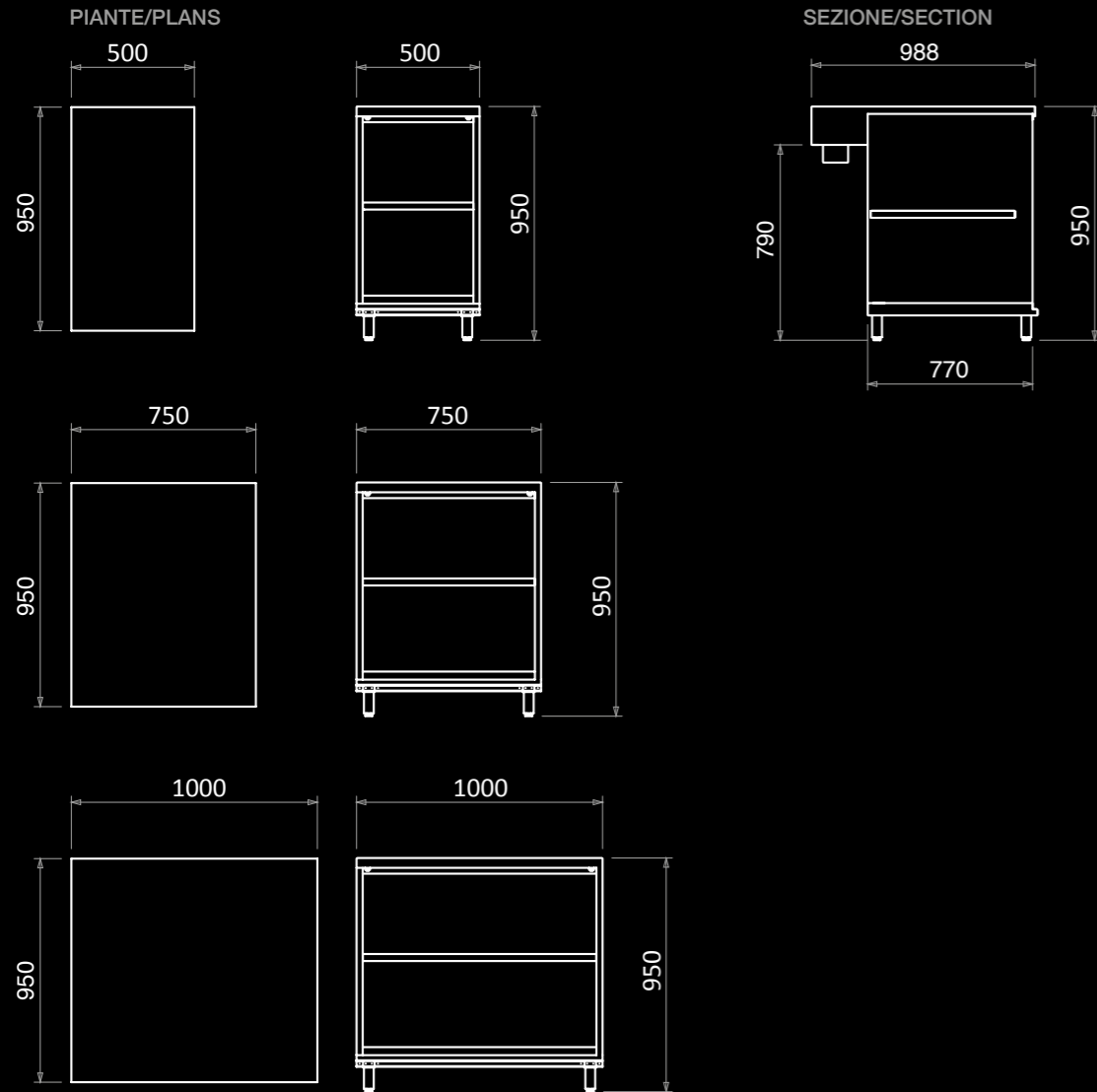

VETRINA VETRI BASSI
DISPLAY CASE WITH LOW GLASS

VETRINA VETRI ALTI
DISPLAY CASE WITH HIGH GLASS

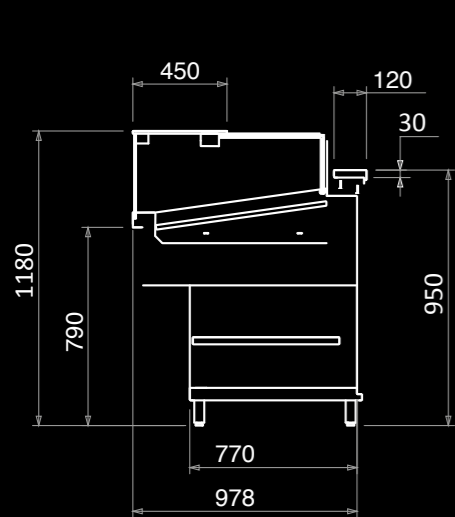

Pianetto di lavoro optional
Optional working top

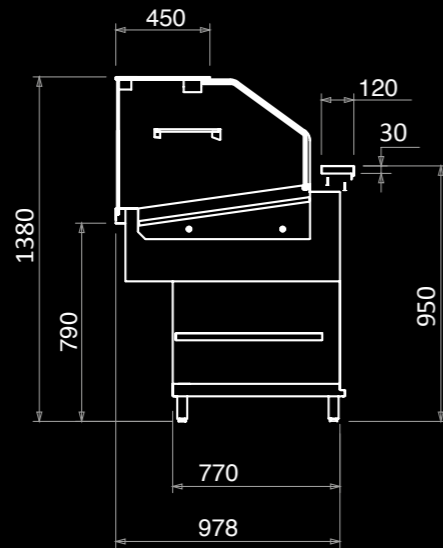

Pianetto di lavoro optional
Optional working top

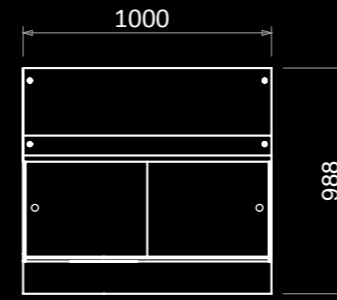

- PRALINERIA (SOLO VETRI BASSI) / PRALINE (ONLY LOW GLASS)
- FREDDO VENTILATO / VENTILATED COLD
- DOPPIO IMPIANTO CALDO/FREDDO / DOUBLE SYSTEM HOT / COLD
- PANE / BREAD
- NEUTRO/PIZZA / NON-REFRIGERATED / PIZZA
- CALDO SECCO / DRY HOT

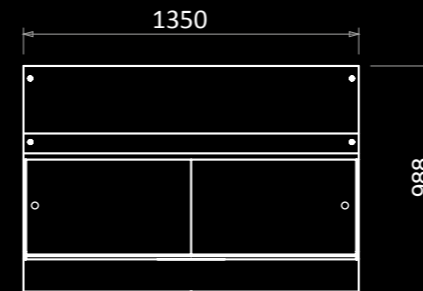

- PRALINERIA (SOLO VETRI BASSI) / PRALINE (ONLY LOW GLASS)
- FREDDO VENTILATO / VENTILATED COLD
- DOPPIO IMPIANTO CALDO/FREDDO / DOUBLE SYSTEM HOT / COLD
- PANE / BREAD
- NEUTRO/PIZZA / NON-REFRIGERATED / PIZZA
- CALDO SECCO / DRY HOT
- BAGNOMARIA (SOLO VETRI ALTI) / BAIN-MARIE (ONLY HIGH GLASS)

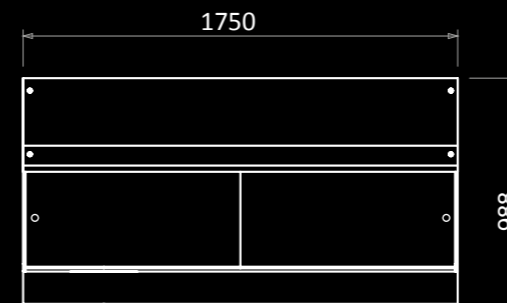

- PRALINERIA (SOLO VETRI BASSI) / PRALINE (ONLY LOW GLASS)
- FREDDO VENTILATO / VENTILATED COLD
- DOPPIO IMPIANTO CALDO/FREDDO / DOUBLE SYSTEM HOT / COLD
- PANE / BREAD
- NEUTRO/PIZZA / NON-REFRIGERATED / PIZZA
- CALDO SECCO / DRY HOT
- BAGNOMARIA (SOLO VETRI ALTI) / BAIN-MARIE (ONLY HIGH GLASS)

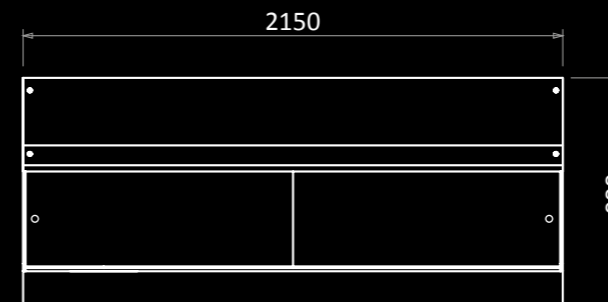

- FREDDO VENTILATO / VENTILATED COLD
- DOPPIO IMPIANTO CALDO/FREDDO / DOUBLE SYSTEM HOT / COLD
- PANE / BREAD
- NEUTRO/PIZZA / NON-REFRIGERATED / PIZZA
- CALDO SECCO / DRY HOT

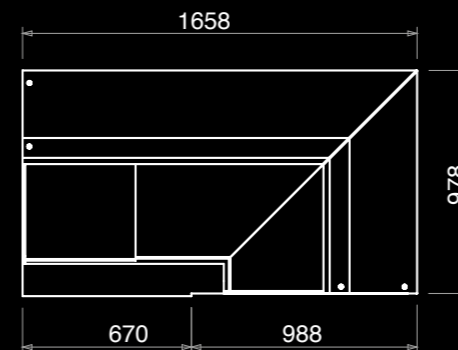

ANGOLO DX / RIGHT CORNER

- FREDDO VENTILATO / VENTILATED COLD
- PANE / BREAD
- NEUTRO/PIZZA / NON-REFRIGERATED / PIZZA

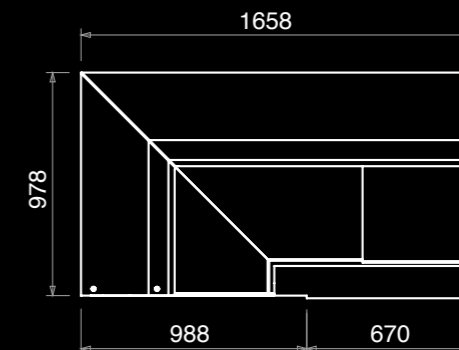

ANGOLO SX / LEFT CORNER

- FREDDO VENTILATO / VENTILATED COLD
- PANE / BREAD
- NEUTRO/PIZZA / NON-REFRIGERATED / PIZZA

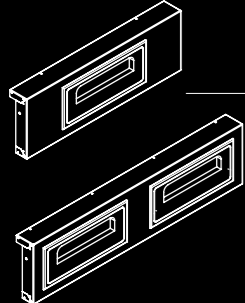
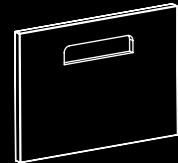
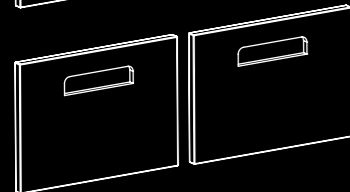
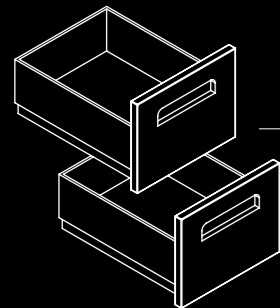
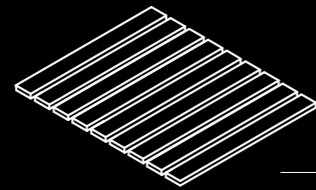
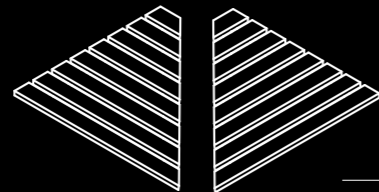
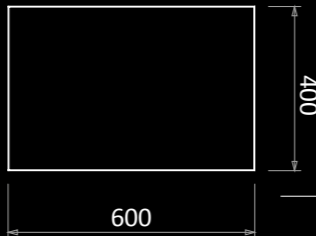
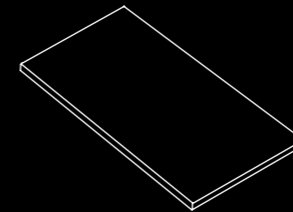
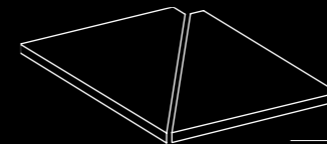
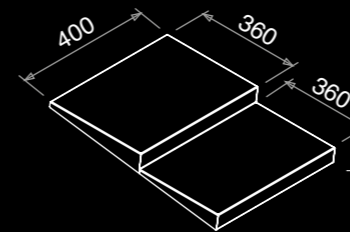
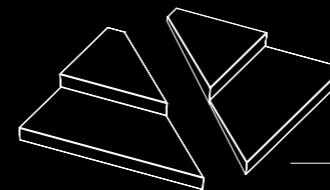
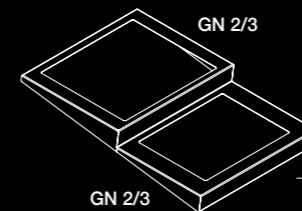
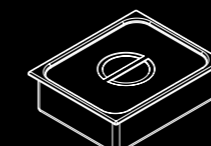
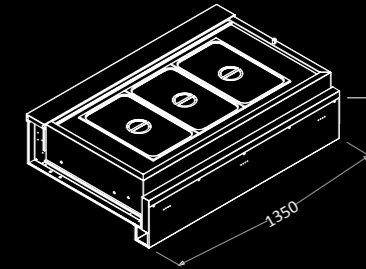
ACCESSORI CASSA/
BANCO INCARTO UNIVERSALI
UNIVERSAL ACCESSORIES FOR
CASH DESK - PACKAGING COUNTERCASSETTO CASSA
(FINITURA INOX LUCIDO)
CASH DESK DRAWER
(FINISH IN POLISHED STAINLESS STEEL)CASSA/INCARTO MM 500 /750
CASH DESK / PACKAGING COUNTER
DIMENSIONS 500/750 MMCASSA/INCARTO MM 1000
CASH DESK / PACKAGING COUNTER
DIMENSIONS 1000 MMANTA
(FINITURA INOX LUCIDO)
DOOR
(FINISH IN POLISHED STAINLESS
STEEL)CASSA/INCARTO MM 500
CASH DESK / PACKAGING COUNTER
DIMENSIONS 500 MMCASSA/INCARTO MM 750/1000
CASH DESK / PACKAGING COUNTER
DIMENSIONS 750/1000 MMCASSETTONE
(FINITURA INOX LUCIDO)
DRAWER
(FINISH IN POLISHED
STAINLESS STEEL)CASSA/INCARTO MM 500
CASH DESK / PACKAGING
COUNTER DIMENSION 500 MMACCESSORI PANE/PIZZA
ACCESSORIES FOR BREAD/PIZZADOGATO PANE
(LISTELLARE FAGGIO ALIMENTARE)
SLATTED COUNTER FOR BREAD
(BEECH WOOD STRIPS FOR CONTACT WITH
FOOD)MODULI MM 1000/1350/1750
MODULES DIMENSIONS 1000 /
1350 / 1750DOGATO PANE ANGOLARE
(LISTELLARE FAGGIO ALIMENTARE)
CORNER SLATTED COUNTER FOR BREAD
(BEECH WOOD STRIPS FOR CONTACT WITH FOOD)TEGLIA PIZZA
(FINITURA INOX LUCIDO)
DISPONIBILE A MISURA
PIZZA DISH
(FINISH IN POLISHED STAINLESS STEEL
AVAILABLE ALSO CUSTOM MADE)TEGLIA MM 600X400
DISH SIZE 600X400 MMACCESSORI
PRALINA / FREDDO VENTILATO / NEUTRO
ACCESSORIES FOR PRALINE / VENTILATED COLD /
NON REFRIGERATEDPIANO ESPOSITIVO LISCIO
(FINITURA INOX LUCIDO)
LINEAR STEPS
(FINISH IN POLISHED STAINLESS STEEL)- REFRIGERATO VENTILATO
VENTILATED COLD
- DOPPIO IMPIANTO FREDDO / CALDO
DOUBLE SYSTEM COLD / HOT
- PRALINERIA / PRALINE
- CALDO SECCO / DRY HOT
- PANE / BREAD
- NEUTRO / NON-REFRIGERATED
- PIZZA / PIZZAPIANI ANGOLARI LISCI
(FINITURA INOX LUCIDO)
PLAIN CORNERS
(FINISH IN POLISHED STAINLESS STEEL)- FREDDO VENTILATO / VENTILATED COLD
- NEUTRO / NON-REFRIGERATEDPIANO ESPOSITIVO A GRADONE
(FINITURA INOX LUCIDO)
STEPPED DISPLAY SURFACE
(FINISH IN POLISHED STAINLESS STEEL)- REFRIGERATO VENTILATO
VENTILATED COLD
- PRALINERIA
PRALINE
- PANE / BREAD
- NEUTRO / NON-REFRIGERATED
- PIZZA / PIZZAPIANI ANGOLARI A GRADONI
(FINITURA INOX LUCIDO)
STEPPED CORNERS
(FINISH IN POLISHED STAINLESS STEEL)- FREDDO VENTILATO / VENTILATED COLD
- NEUTRO / NON-REFRIGERATEDPIANO ESPOSITIVO GASTRONORM
(FINITURA INOX LUCIDO)
GASTRONORM DISPLAY SURFACE
(FINISH IN POLISHED STAINLESS STEEL)- REFRIGERATO VENTILATO SOLO LINEARE
VENTILATED COLD (ONLY FOR LINEAR MODULES)VASCHETTE GASTRONORM
(PER GRADONI GASTRONORM)
GASTRONORM TRAYS
(FOR GASTRONORM STEPS)ACCESSORI BAGNOMARIA
ACCESSORIES FOR BAIN-MARIEVASCHETTE
GASTRONORM
GASTRONORM TRAYS

3 GN 1/1

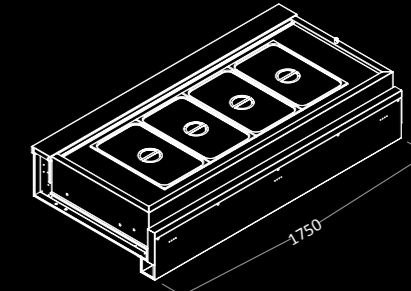

4 GN 1/1

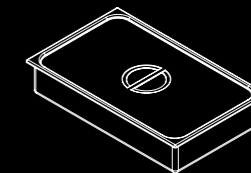

GN 1/1

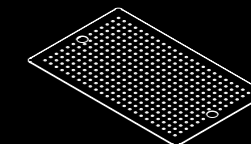
GRIGLIA 1/1
DISPONIBILI A MISURA
(AVAILABLE CUSTOM MADE)

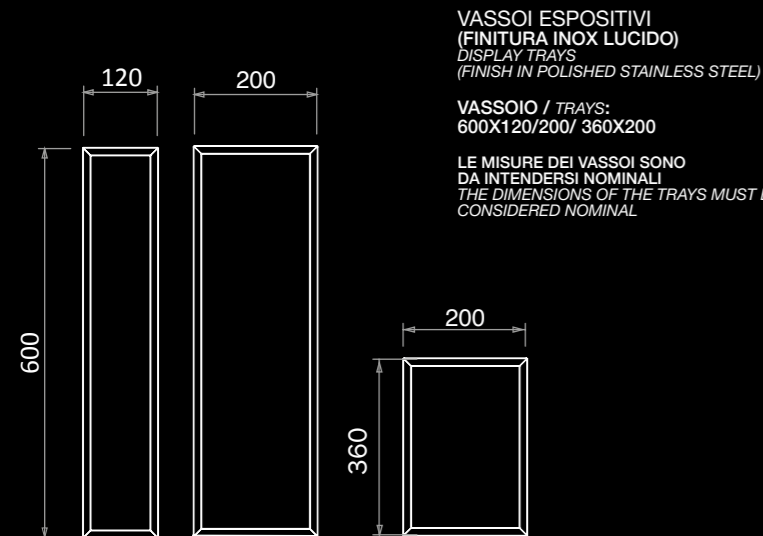
ACCESSORI UNIVERSALI
UNIVERSAL ACCESSORIES

VASSOI ESPOSITIVI
(FINITURA INOX LUCIDO)
DISPLAY TRAYS
(FINISH IN POLISHED STAINLESS STEEL)

VASSOIO / TRAYS:
600X120/200/ 360X200

LE MISURE DEI VASSOI SONO
DA INTENDERSI NOMINALI
THE DIMENSIONS OF THE TRAYS MUST BE
CONSIDERED NOMINAL

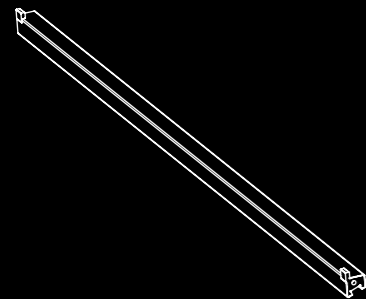

ILLUMINAZIONE
SUPPLEMENTARE
MENSOLA (LED)
ADDITIONAL LIGHTING
FOR SHELF (LED)

- FREDDO VENTILATOI / VENTILATED COLD
- DOPPIO IMPIANTO CALDO/FREDDOI / DOUBLE SYSTEM HOT / COLD
- PANE / BREAD
- NEUTRO/PIZZA / NON-REFRIGERATED / PIZZA
- CALDO SECCO / DRY HOT

SOLO PER VERSIONI VETRI ALTI
ONLY FOR VERSIONS WITH HIGH GLASS



KIT DI CANALIZZAZIONE
KIT FOR DUCT SYSTEM

VETRI BASSI / LOW GLASS
- FREDDO VENTILATOI / VENTILATED COLD
- DOPPIO IMPIANTO CALDO/FREDDOI / DOUBLE SYSTEM HOT / COLD
- PANE / BREAD
- NEUTRO/PIZZA / NON-REFRIGERATED / PIZZA
- CALDO SECCO / DRY HOT

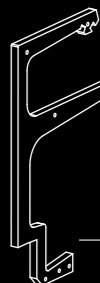

VETRI ALTI / HIGH GLASS
- FREDDO VENTILATOI / VENTILATED COLD
- DOPPIO IMPIANTO CALDO/FREDDOI / DOUBLE SYSTEM HOT / COLD
- PANE / BREAD
- NEUTRO/PIZZA / NON-REFRIGERATED / PIZZA
- CALDO SECCO / DRY HOT

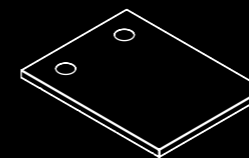
ACCESSORI PER BASAMENTO
COUNTER ACCESSORIES

RIPIANO INTERMEDIO (FINITURA PLASTIFICATO)
INTERMEDIATE SHELF (PLASTIC FINISH)

- PRALINERIA / PRALINE
- FREDDO VENTILATO / VENTILATED COLD
- DOPPIO IMPIANTO CALDO/FREDDO / DOUBLE SYSTEM HOT / COLD
- PANE / BREAD
- NEUTRO/PIZZA / NON-REFRIGERATED / PIZZA
- CALDO SECCO / DRY HOT
- BAGNOMARIA / BAIN-MARIE

LINEARI E/O 90° DX/SX / LINEAR AND/OR 90° LH/RH

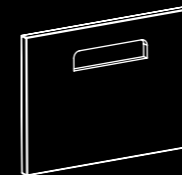

ANTA (FINITURA INOX LUCIDO)
DOOR (FINISH IN POLISHED STAINLESS STEEL)

- PRALINERIA / PRALINE
- FREDDO VENTILATO / VENTILATED COLD
- DOPPIO IMPIANTO / DOUBLE SYSTEM HOT / COLD
- PANE / BREAD COUNTER
- NEUTRO/PIZZA / NON-REFRIGERATED / PIZZA
- CALDO SECCO / DRY HOT
- BAGNOMARIA / BAIN-MARIE

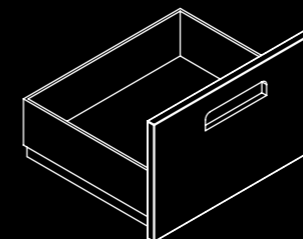
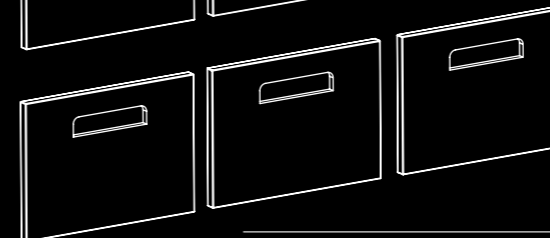
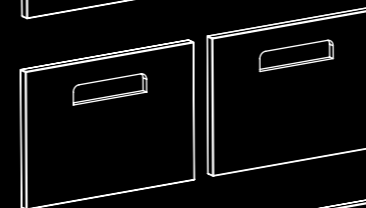

CASSETTONE
(FINITURA INOX LUCIDO)
DRAWER
(FINISH IN POLISHED STAINLESS STEEL)

- PRALINERIA / PRALINE
- FREDDO VENTILATO / VENTILATED COLD
- DOPPIO IMPIANTO / DOUBLE SYSTEM
- PANE / BREAD
- NEUTRO/PIZZA / NON-REFRIGERATED / PIZZA
- CALDO SECCO / DRY HOT
- BAGNOMARIA / BAIN-MARIE

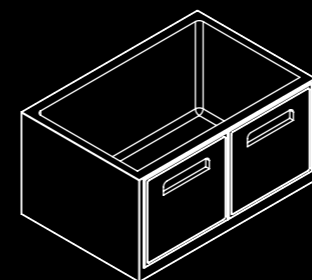
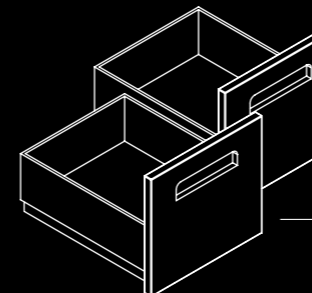

CELLA DUE VANI
CABINET WITH TWO COMPARTMENTS

- PANE 1350 / BREAD 1350
- NEUTRO/PIZZA 1350 / NON-REFRIGERATED / PIZZA 1350
- CALDO SECCO 1350 / DRY HOT 1350
- BAGNOMARIA 1350 / BAIN-MARIE 1350

UNITÀ ESTERNA / EXTERNAL UNIT

- PANE 1750 / BREAD 1750
- NEUTRO/PIZZA 1750 / NON-REFRIGERATED / PIZZA 1750
- CALDO SECCO 1750 / DRY HOT 1750
- BAGNOMARIA 1750 / BAIN-MARIE 1750

UNITÀ INTERNA / INTERNAL UNIT

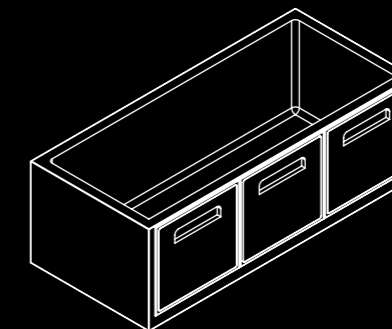

CELLA TRE VANI
CABINET WITH THREE COMPARTMENTS

- PANE 1750 / BREAD 1750
- NEUTRO/PIZZA 1750 / NON-REFRIGERATED / PIZZA 1750
- CALDO SECCO 1750 / DRY HOT 1750

UNITÀ ESTERNA / EXTERNAL UNIT

- PANE 2150 / BREAD 2150
- NEUTRO/PIZZA 2150 / NON-REFRIGERATED / PIZZA 2150
- CALDO SECCO 2150 / DRY HOT 2150

UNITÀ INTERNA / INTERNAL UNIT

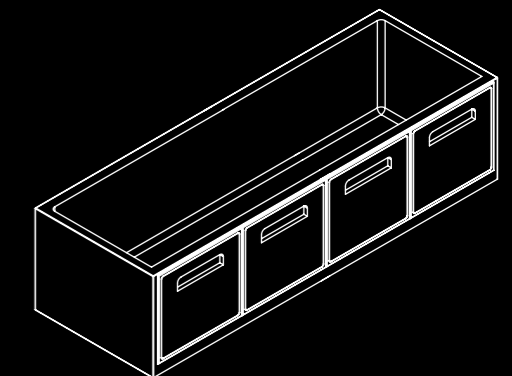

CELLA QUATTRO VANI
CABINET WITH FOUR COMPARTMENTS

- PANE 2150 / BREAD 2150
- NEUTRO/PIZZA 2150 / NON-REFRIGERATED / PIZZA 2150
- CALDO SECCO 2150 / DRY HOT 2150

UNITÀ ESTERNA / EXTERNAL UNIT

AD **BRX**

Photography
Livio Fantozzi

Styling
Marida Gajtani

Printing
Grapho5

October 2015

IL CATALOGO È DI PROPRIETÀ BRX SRL. TUTTI I DIRITTI SONO RISERVATI.
È VIETATA OGNI FORMA DI RIPRODUZIONE ANCHE PARZIALE.

*THIS CATALOGUE IS OF EXCLUSIVE PROPRIETÀ OF BRX SRL. ALL RIGHTS
ARE RESERVED. ANY FORM OF TOTAL OR PARTIAL REPRODUCTION OF
CATALOGUE IS STRICTLY FORBIDDEN.*

BRX SRL SI RISERVA DI APPORTARE MODIFICHE AI DATI E I DETTAGLI DEI
PRODOTTI PRESENTI SU QUESTO CATALOGO ANCHE SENZA PREAVVISO.

*BRX SRL MAY AT ANY TIME MODIFY THE SPECIFICATIONS AND DETAILS OF
THE PRODUCTS PRESENT IN THE CATALOGUE.*



BRX srl Via Luciano Lama, 38/1 - 61025 Montelabbate (PU) - Italy
Tel. +39 0721 499611 - Fax +39 0721 909376 - info@brxitalia.com
www.brxitalia.com